



# Manual - Orion XS 12/12-50A DC-DC battery charger

# Table of Contents

<b>1. Safety instructions</b> .....	<b>1</b>
<b>2. General</b> .....	<b>2</b>
2.1. Introduction .....	2
2.2. Features .....	2
2.3. What's in the box? .....	4
<b>3. Installation</b> .....	<b>5</b>
3.1. Mounting .....	5
3.2. Cable type recommendations .....	5
3.3. Cable and fuse recommendations .....	6
3.4. Recommended torque .....	6
3.5. GND connection .....	7
3.6. Strain Relief .....	7
3.7. Connection setup for DC-DC power supply mode .....	8
3.8. Connection setup for charger mode .....	8
3.9. Connection setup for remote on/off .....	9
3.10. Engine shutdown detection override wiring .....	10
<b>4. Operation, configuration and monitoring</b> .....	<b>12</b>
4.1. Engine shutdown detection .....	12
4.2. Engine shutdown detection sequence .....	12
4.3. Setup for Euro 6 vehicles .....	13
4.4. LED indicators .....	14
4.5. Setup & monitoring with VictronConnect .....	15
4.5.1. Setup .....	15
4.5.2. Charger mode settings .....	15
4.5.3. Charger mode - Battery settings .....	16
4.5.4. Power supply mode .....	17
4.5.5. Power supply mode settings .....	17
4.5.6. Engine shutdown detection & input voltage lock-out .....	18
4.5.7. Product information page .....	20
4.5.8. Monitoring .....	21
4.5.9. Charger mode - Status screen .....	21
4.5.10. Charger mode - Graph screen .....	22
4.5.11. History screen .....	22
4.5.12. Trends screen .....	23
4.5.13. Instant readout over BLE .....	23
4.6. Monitoring with a GX device .....	24
4.7. Remote sensing with VE.Smart Networking .....	24
<b>5. Troubleshooting &amp; Support</b> .....	<b>26</b>
5.1. The Orion XS is not operational .....	26
5.1.1. Visual Check .....	26
5.1.2. Battery supply check .....	27
5.1.3. Battery not charged .....	27
5.1.4. Reverse battery polarity .....	28
5.1.5. Battery full .....	28
5.1.6. Remote terminal is missing, is disconnected or external control is active .....	28
5.1.7. The charger is disabled .....	29
5.2. Batteries are undercharged .....	29
5.2.1. Too much DC load .....	29
5.2.2. Battery charge voltages are too low .....	29
5.2.3. Battery is almost full .....	30
5.2.4. Battery cable voltage drop .....	30
5.2.5. Temperature difference between Orion XS and battery .....	31
5.2.6. Insufficient alternator power .....	31
5.2.7. Wrong temperature compensation setting .....	31
5.2.8. Battery charge current too low .....	31
5.3. Batteries are overcharged .....	31
5.3.1. Battery charge voltages too high .....	31
5.3.2. Battery unable to deal with equalization .....	32
5.3.3. Battery old or faulty .....	33

5.4. Full rated output not reached .....	33
5.5. Communication issues .....	34
5.5.1. VictronConnect issues .....	34
5.5.2. VE.Direct port communication issues .....	34
5.5.3. Bluetooth issues .....	34
5.6. Settings or firmware issues .....	35
5.6.1. Incorrect settings .....	35
5.6.2. Firmware issues .....	35
5.6.3. Interrupted firmware update .....	35
5.7. Error and warning code overview .....	36
<b>6. Technical data .....</b>	<b>38</b>
6.1. Technical specifications .....	38
6.2. Compliance .....	38
6.3. Enclosure dimensions .....	39



# 1. Safety instructions



**SAVE THESE INSTRUCTIONS – This manual contains important instructions that shall be followed during installation and maintenance.**



**Danger of explosion from sparking and danger of electric shock**

## General

Please read the safety instructions below before installing and using the Orion XS to avoid risks of fire, electric shocks, personal injuries or equipment damage.

This product is designed and tested in accordance with international standards. The equipment should be used for its designated application only and in accordance with the specified operating parameters.

## Installation

- For electrical work, follow the local national wiring standards, regulations and these installation instructions.
- Install the product in a heatproof environment. Ensure therefore that there are no chemicals, plastic parts, curtains or other textiles, etc. in the immediate vicinity of the equipment.
- It is normal for the Orion XS to get hot during operation. Keep any objects that are heat-sensitive away.
- Never install or use the product at sites where gas or dust explosions could occur.
- Use flexible multi-stranded copper cables for the connections (UL: Class I; IEC: Class 5).
- The installation must include a fuse in accordance with the recommendations in the table [Cable type recommendations \[5\]](#).

## Operation, service and maintenance

- Ensure that the equipment is used under proper operating conditions.
- This device is not to be used by persons (including children) with reduced physical, sensory or mental capabilities or lack of experience and knowledge unless they have been given supervision or instruction.
- Always provide proper ventilation during charging.
- Avoid covering the Orion XS 12/12-50A DC-DC battery charger.
- Never place the battery charger on top of the battery during charging.
- Prevent sparks close to the battery. A battery being charged could emit explosive gasses.
- Refer to the battery manufacturer's specifications to ensure that the battery is suitable for use with this product. The safety instructions of the battery manufacturer must always be observed.
- In addition to this manual, the system operation or service manual must include a battery maintenance manual applicable to the type of batteries used.
- Do not use the device if it shows any signs of damage or does not function properly.
- Do not use the Orion XS 12/12-50A DC-DC battery charger if it is broken, defective, cracked, damaged, or malfunctioning.
- The Orion XS 12/12-50A DC-DC battery charger contains no serviceable parts.
- Regular maintenance of the Orion XS 12/12-50A DC-DC battery charger is not required.
- Avoid moisture, oil/soot/vapours, and keep the device clean.
- Clean the front side of the Orion XS 12/12-50A DC-DC battery charger using a dry cloth.

## 2. General

### 2.1. Introduction

The Orion XS can be used as a battery charger or as a power supply with a wide input and output voltage range.

In charger mode, the four-stage charge algorithm will increase battery life by properly charging the battery.

Especially in the case of vehicles with a Euro 5 or 6 smart alternator, which often supplies charging voltage that is too low even with the engine running or in the event of a voltage drop over long cables, controlled charging is crucial.

Controlled charging also protects the alternator in lithium systems from overloading, as the low impedance of lithium batteries results in a high alternator current.

In power supply mode, the output voltage remains stable regardless of the applied load or fluctuating input voltage (within the specified range).

The output voltage is fully adjustable and remains independent of the input voltage, thanks to the automatic buck-boost control. This control also guarantees that the current will never exceed the set value, even when the input voltage is higher than the output voltage.

The Orion XS can be set only to supply power when the engine is running. This is possible thanks to the integrated engine shutdown detection. This eliminates the need to adjust in-vehicle wiring or add an engine detection sensor to determine if charging can start. It also prevents the voltage on board the vehicle from getting too low. In addition to this detection, the Orion XS can also be forced on via the remote on/off port.

The Orion XS is fully programmed and monitored using the [VictronConnect App](#). This also includes remote access via VictronConnect-Remote (VC-R) when connected to a GX device (requires a GX device connection to the [VRM Portal](#)) via the integrated VE.Direct port, monitoring via the GX Remote Console or from a PC, Apple computer with macOS or Android device in conjunction with a [VE.Direct to USB interface](#) and VictronConnect. Discover all setting and monitoring options in the [Setup & monitoring with VictronConnect \[15\]](#) chapter and the [VictronConnect manual](#).

### 2.2. Features

#### Smart alternator compatibility

It is common for vehicle manufacturers to install "smart" ECU (Engine Control Unit) controlled alternators to increase fuel efficiency and reduce emissions. Smart alternators provide variable output voltage and shut down when not needed. The Orion XS has an integrated mechanism that detects whether the engine is running (engine shutdown detection), so the charger is only activated when the alternator is supplying power. This ensures that the charger only draws power when the alternator supplies power. Please refer to the [Engine shutdown detection \[12\]](#) chapter and the [Setup for Euro 6 vehicles \[13\]](#) section for more information.

#### Separation of the starter battery and the service battery

The Orion XS separates the starter battery from the service battery.

#### Comprehensive electronic protection

The charger is protected against overtemperature (heat sink >90 °C) by reducing the output power when the maximum product temperature is reached.

- Protected against overload
- Protected against short circuit
- Protected against excessive temperatures

#### Adaptive charging in four stages

The Orion XS is configured by default for a four-stage charging process.

##### • Bulk — Absorption — Float — Storage

###### • Bulk

During this phase, the Orion XS supplies as much charging current as possible to quickly charge the batteries.

###### • Absorption

When the battery voltage reaches the absorption voltage setting, the charger switches to constant voltage aka absorption mode. For lead-acid batteries, it is important that the absorption time is kept short during superficial discharges to avoid

overcharging the battery. After a deep discharge, the absorption time is automatically increased to ensure that the battery is fully charged again. For lithium batteries, the absorption time is fixed, 2 hours by default. Fixed or adjustable modes can be selected via the battery settings.

- **Float**

During this phase, the battery is charged with a trickle charge voltage to keep it in a fully charged state. When the battery voltage drops far below this level, for example, due to a high load for at least 1 minute, a new charge cycle is activated.

- **Storage**

The battery voltage is maintained at the configured storage voltage, which is slightly reduced compared to the float voltage to minimise gassing and extend battery life whilst the battery is unused and on continuous charge.

### **Flexible charge algorithm**

The Orion XS has fully programmable charge algorithms and eight pre-programmed battery settings. Configurable with VictronConnect.

### **Adaptive Absorption Time**

In adaptive absorption time mode, the correct absorption time is calculated automatically. Configurable with VictronConnect.

### **Repeated Absorption**

To refresh the battery and prevent slow self-discharge while in storage stage over an extended period, a 1-hour absorption charge will automatically occur every 7 days (or as configured).

### **Temperature-compensated charging**

The optimum charge voltage of a lead-acid battery is inversely proportional to temperature. The Orion XS measures the ambient temperature at the start of the charging phase and compensates for the temperature during charging. The temperature is measured again when the battery charger is in low current mode during absorption or storage. Special settings for a cold or warm environment are therefore not required.

### **Adjustable charge current**

The charge current is adjustable with a minimum step size of 0.1A. Configurable with VictronConnect.

### **Low-temperature shutdown**

Prevents damage to lithium batteries by turning off the charger at low temperatures. Configurable with VictronConnect.

### **Input voltage lock-out**

Shut down the charger when the input voltage falls below the lock-out value and restart when the input voltage rises above the restart value. Configurable with VictronConnect.

### **Remote On/Off**

The inverter can be switched on and off remotely via the remote on/off connector or the VictronConnect App. Typical applications include a wired switch or a lithium battery with a Battery Management System (BMS) that has an ATC (allowed to charge) output.

### **DVCC controlled**

The Orion XS can be DVCC controlled via a GX device, provided it is connected to the GX device via the VE.Direct port and the Orion is switched to charger mode (there is no DVCC control when the Orion XS is in power supply mode). Charging currents and voltages are then set automatically; thus, the internal bulk, absorption, and float algorithms are no longer used. Charging or discharging are stopped at low or high cell voltage or low temperature.

For more details about DVCC, please see the GX device manual.

### **Monitoring locally via a GX device as well as remotely on the [VRM Portal](#)**

Monitor and control (on/off) the Orion XS via a wired VE.Direct connection from a GX device such as the [Cerbo GX](#), [Ekrano GX](#), or use a PC, Apple computer (requires macOS), or Android device in conjunction with VictronConnect.

If the Orion XS is connected to a GX device with internet access, you can also monitor the Orion XS remotely via the VRM portal. Predefined widgets with all the necessary parameters are already available in the VRM portal. You can also create your own customised widgets.

### **Configuration and monitoring via VictronConnect App and Bluetooth**

Built-in Bluetooth Smart: the wireless solution to change settings, monitor activities and update software using Apple and Android smartphones, tablets or other devices. Various parameters can be adjusted and monitored with the [VictronConnect App](#).

This also includes Instant Readout, which displays the most important data of the Orion XS (and other smart products) on the Device list page without the need to connect to the product. This includes visual notifications of warnings, alarms, and errors that enable diagnostics at a glance.

VictronConnect is available for Android, iOS, Windows and macOS. See the [VictronConnect manual](#) to get the most out of the VictronConnect app when connected to a Victron smart product.

### Remote voltage-, temperature and/or current sensing via VE.Smart Networking

Use VE.Smart Networking to receive Vsense, Tsense and Isense data over the wireless network for your Orion XS DC-DC battery charger, for example, from a BMV, a SmartShunt, or a Smart Battery Sense<sup>1</sup>). The charger uses the available information from the battery to optimise the charging parameters. This improves charging efficiency and extends battery life. For more information, please see [Remote sensing with VE.Smart Networking \[24\]](#) and the VE.Smart Networking manual which can be downloaded from the [VictronConnect download section](#). Please note that the Orion XS does not support synchronised charging.

<sup>1</sup>) The Smart Battery Sense does not support Isense.

### Waterproof

The Orion XS complies with ingress protection rating IP65; this means the product is dust-tight and protected against heavy rain.

### Silent

The heat is dissipated through natural convection, eliminating the need for a noisy cooling fan.

## 2.3. What's in the box?





## 3. Installation

### 3.1. Mounting

- Mount vertically on a non-flammable surface, with the power terminals facing downwards.
- For optimum performance, a minimum of 10cm space should be kept free around the product for cooling. With limited cooling, e.g. due to insufficient ventilation, the charging current will be reduced sooner than at the specified maximum ambient temperature. With improved airflow (e.g. forced airflow), the performance will greatly improve.
- With limited cooling or extreme ambient temperature, the charger can become hot (especially the bottom plate). Due to internal temperature control, the heat sink will never get warmer than 90 °C; this is no problem for the charger. Make sure that the mounting surface can withstand this temperature.
- Mount close to the battery but never directly above the battery (to prevent damage from gassing of the battery).

### 3.2. Cable type recommendations

For correct connection of a cable to the input/output screw terminals, stranded wires with flexible cores can be used according to:

- IEC 60228 - Class 2 (stranded), Class 5 (flexible)
- UL486A-B - Class B/C (stranded), Class I (flexible)

Cables with twisted cores are very stiff, which means that they are rarely used in practice. The table below provides an overview of how to recognise the different wire classes.

Single wire diameter in the bundle		
Nominal cross-section	Class 5 (IEC)	Class I (UL)
10mm <sup>2</sup> / 8AWG (8.4mm <sup>2</sup> )	0.4mm	24AWG
16mm <sup>2</sup> / 6AWG (13.3mm <sup>2</sup> )	0.4mm	24AWG
4AWG (21.1mm <sup>2</sup> )	0.4mm	24 AWG

The use of ferrules is not required for cables from the above table. If an even thinner cable is used, a ferrule can help to bundle the loose wires. However, it is up to the installer to make sure that the cable is properly secured. The connecting cable, with or without a ferrule, should be adequately clamped to ensure low contact resistance.

Note: If you prefer using a ferrule, opt for a bootlace ferrule to ensure the strain relief grips the cable insulation as intended. A 16mm<sup>2</sup> cable with a ferrule will only fit if crimped hexagonally; a square crimp will not fit.



Hexagonally crimped bootlace ferrule

#### Preparation for correct mounting of fine-strand wires in the screw terminal block

1. Cut the cable straight with no loose or staggered threads. Using wire cutters will result in a straight cut.
2. Make sure no fine wires are cut when stripping the insulation.
3. Open the screw on the screw terminal block completely to prevent fine wires from getting caught behind the screw and bunching up. Pay particular attention to this when using the maximum wire diameter.
4. Tighten the screw with the correct torque; see [Recommended torque \[6\]](#) and note the wire size and wire class. Never apply less than the recommended torque.



- Hold the recommended torque for at least 5 seconds; this will give the screw time to settle to the set torque. This maximises the force on the wire, thereby maintaining a gas-tight contact pattern during heating and cooling cycles over time. Take the time to do it right. This is important. This is a UL486 test requirement and a requirement for all factory and field installations.

### 3.3. Cable and fuse recommendations

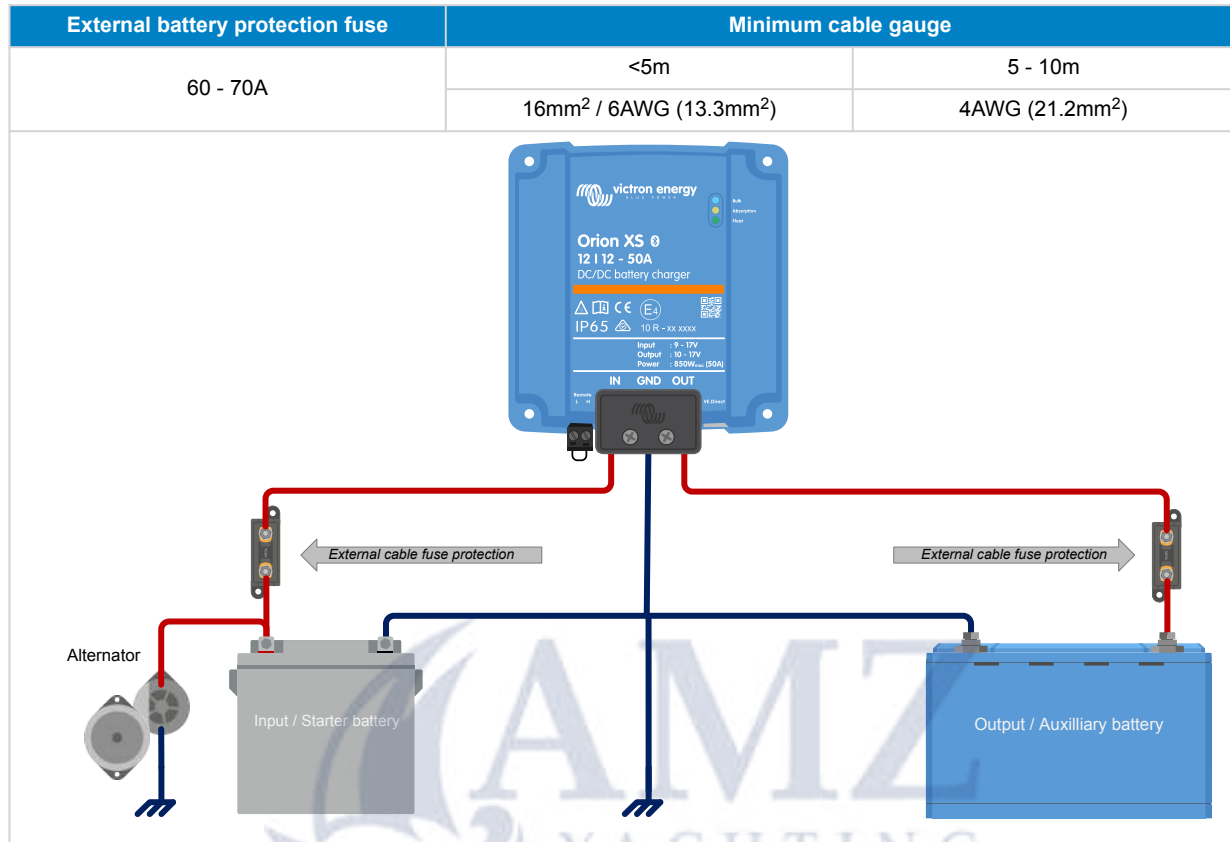

### 3.4. Recommended torque



AWG	mm <sup>2</sup>	in-lb	Nm
4	21.2	35	4
6	16		
8	10	25	2.8
10	6	20	2.3
12	4		

For the cable cover use a torque of <0.7Nm (6 in-lb).

### 3.5. GND connection

In many cases, the GND connection is connected to the chassis via a cable lug. For a low-impedance connection, the cable lug must have direct contact with the metal of the chassis, the contact surface must therefore be free of paint, see below images.

 Make sure the GND connection on the vehicle's chassis has a low impedance.

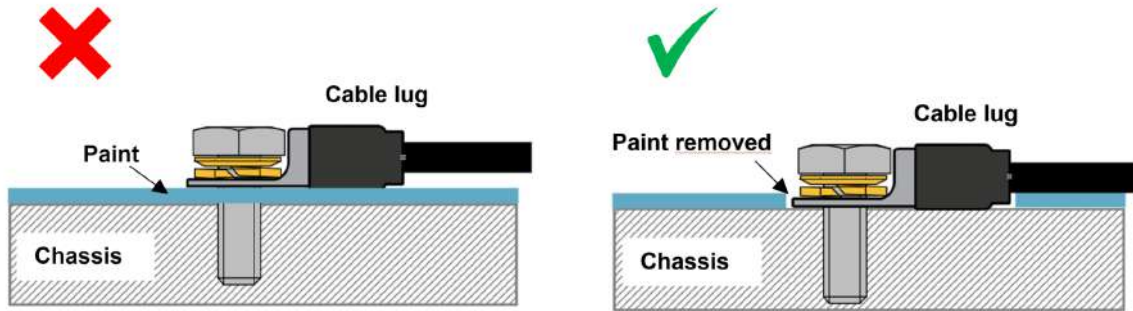

### 3.6. Strain Relief

The connector type in this charger is sensitive to constant mechanical stress. Prolonged loading (pulling, pushing or twisting) of the connector should be avoided. For this reason, the charger is equipped with a strain relief in the cable cover. It is very important that the strain relief is applied correctly. The weight of the wire or other forces hanging from the connectors should be close to zero.

 Insufficient strain relief can lead to connector damage in the long term.

The strain relief in the cable cover is designed so that wiring with an outer diameter >9mm is sufficiently clamped. With thinner wiring, the diameter must be increased to >9mm; this can be done simply by applying shrink tubing.

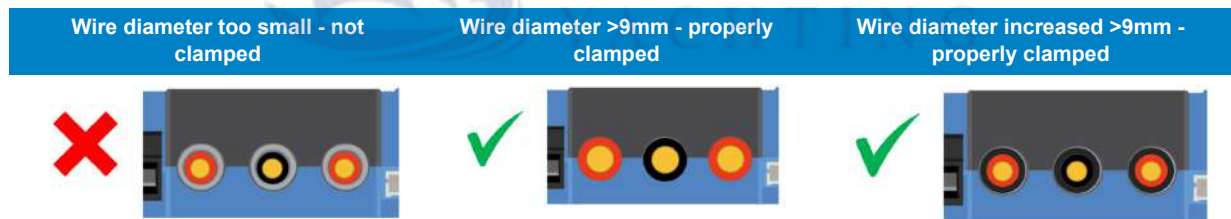

### 3.7. Connection setup for DC-DC power supply mode

1. Disconnect the remote on/off (remove the wire bridge or remove the entire remote on/off terminal block).
2. Connect the input power cables.
3. Open the VictronConnect app to set up the product (**always adjust the output voltage before connecting a load or battery to the output**).  
For details, see [Power supply mode settings \[17\]](#).
4. Connect the load.
5. Reconnect the remote on/off to activate the product. The product is now ready for use.

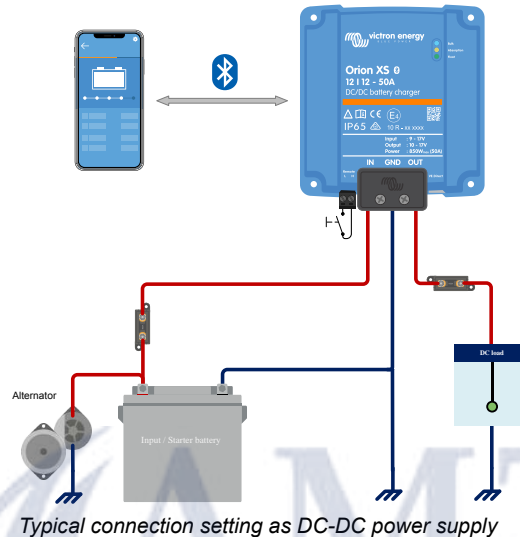

### 3.8. Connection setup for charger mode

1. Disconnect the remote on/off (remove the wire bridge or remove the entire remote on/off terminal block).
2. Connect the input power cables.
3. Open the VictronConnect App to set up the product (**always set up the correct charging algorithm before connecting a battery to the output**).  
For details, see [Charger mode settings \[15\]](#).
4. Connect the battery to be charged.
5. Reconnect the remote on/off to activate the product. The product is now ready for use.

*Typical connection setting as DC-DC battery charger*

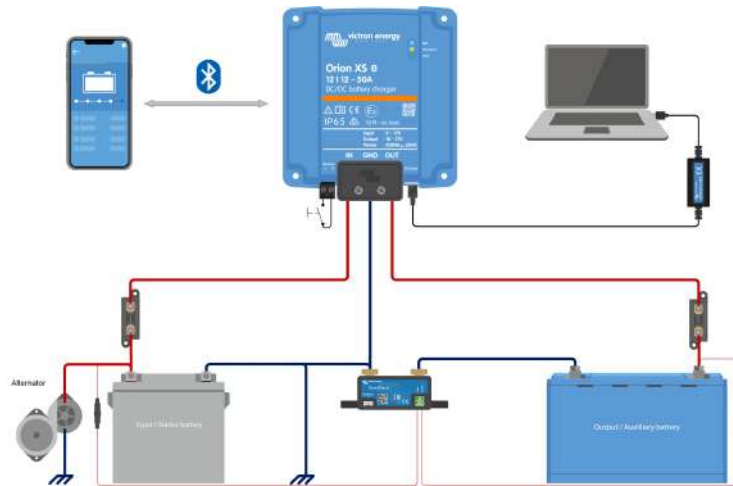

Typical connection setting as DC-DC battery charger

### 3.9. Connection setup for remote on/off

The recommended use of the remote on/off input is:

- A switch wired between the L-H pins (ON switch level impedance between L-H pins: <math>< 30k\Omega</math>)
- A switch wired between (input/output) battery positive and H pin (ON switch level > 4V)
- A switch wired between the L-pin and (input/output) ground (ON switch level < 6V)
- BMS control via the H-pin (e.g. between BMS ATC output and H-pin)

 Note the voltage tolerance between L- & H-pin: +/- 70VDC

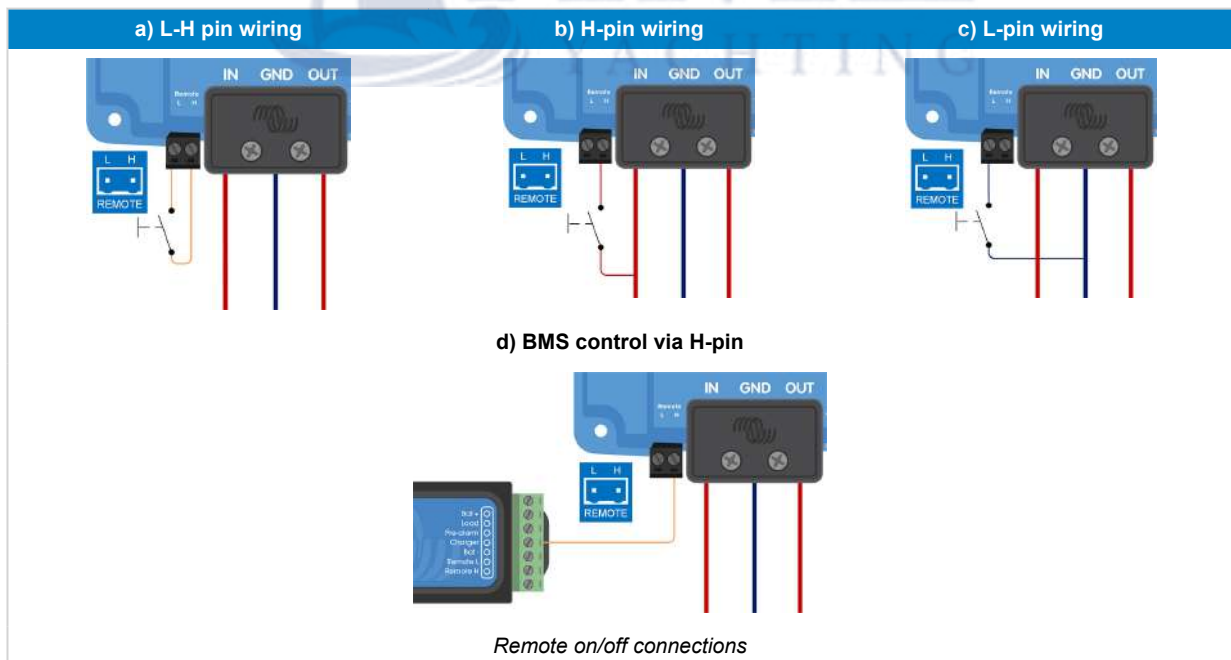

### 3.10. Engine shutdown detection override wiring

In charger mode, the engine shutdown detection sequence determines whether the conditions are met to enable charging; see the [Engine shutdown detection \[12\]](#) chapter. Overriding the engine shutdown detection allows the user to decide for himself whether charging is allowed. Applying >8V to the L-pin overrides the engine shutdown detection and activates the charger. This can be done, for example, with an ignition switch, CAN-bus engine running detector, etc.

**i** This function does not override the remote on/off function. Remote connection a), b) or d), as shown in section [Connection setup for remote on/off \[9\]](#), must be configured in combination with engine shutdown detection override. See examples in the below images.

**Enable charging via an ignition switch i.c.w. remote on/off option a)**      **Enable charging via an ignition switch i.c.w. external on/off option (e.g. BMS ATC contact) d)**

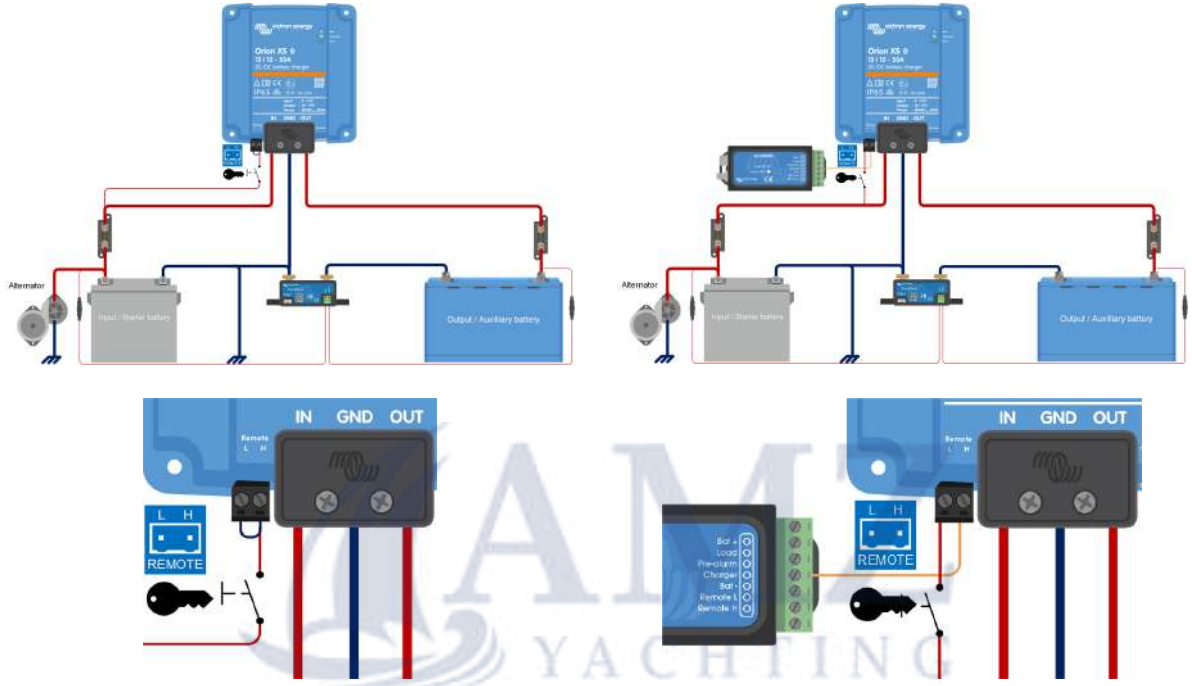

Engine shutdown detection override connection diagram

**i** When the ignition switch is switched off, the charger will return to engine shutdown detection mode, it will not turn off the charger.

To force enable/disable charging (i. e. turn the Orion XS on/off) without interference from the engine shutdown detection, a remote option as given in section [Connection setup for remote on/off \[9\]](#) must be wired, and the engine shutdown detection must be switched off in VictronConnect, see figure below.

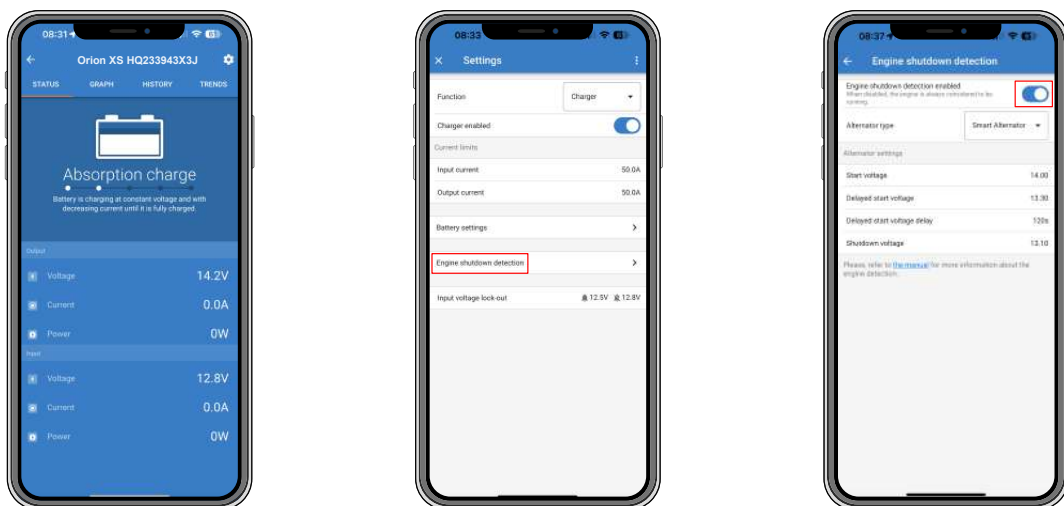

*Disable engine shutdown detection*



When the engine shutdown detection has been switched off in Victron Connect ('forced charging'), **current will be drawn from the starter battery even if the engine is not running.**



During 'forced charging' the input voltage lockout is the only limit left to disable charging automatically, make sure this level is not set too low, in most applications 12.5V is sufficiently low.



## 4. Operation, configuration and monitoring

### 4.1. Engine shutdown detection

The engine shutdown detection mechanism simplifies your Orion XS system by detecting if the engine is running without wiring additional switches or sensors. The factory default setting will work with most conventional and smart alternators but can be re-configured with the VictronConnect App.

Configuring engine shutdown detection is determined by the alternator voltage. Conventional alternators will generate a fixed voltage (e.g. 14V), whereas the voltage of smart alternators can vary between 12.5V to 15V (for a 12V system). Smart alternators in a regenerative braking system often show large voltage variations.

Engine shutdown detection is only active in charger mode. The feature can be configured, disabled and reactivated as described in the [Engine shutdown detection & input voltage lock-out \[18\]](#) section. In power supply mode, the Input voltage lock-out determines when the output is active.

### 4.2. Engine shutdown detection sequence

The following procedure describes the operation of the engine shutdown detection sequence.

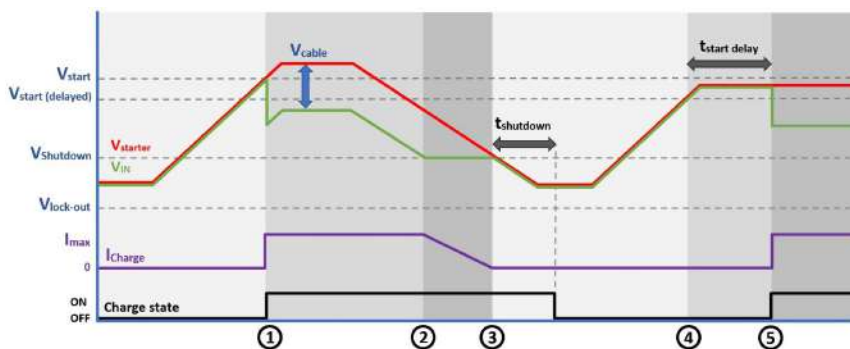
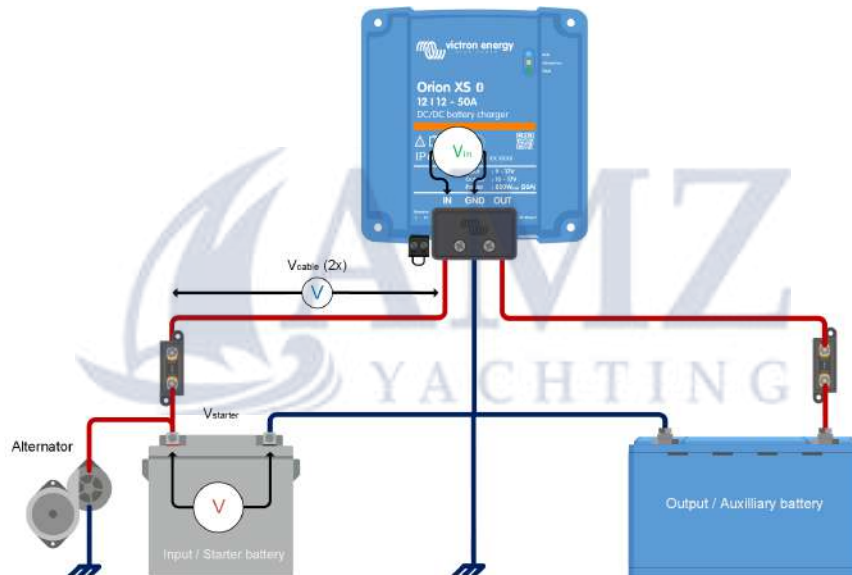

#### Engine shutdown detection sequence

- 0 → 1: If the engine runs, the alternator voltage will ramp up. When  $V_{\text{starter}} > V_{\text{start}}$ , charging is enabled.
- 1 → 2: The input current produces a voltage across the input cable ( $V_{\text{cable}}$ ); this voltage reduces the voltage measured by the charger ( $V_{\text{IN}}$ ). If  $V_{\text{IN}} > V_{\text{shutdown}}$ , the charger will operate at  $I_{\text{max}}$ .
- 2 → 3: If  $V_{\text{IN}} \leq V_{\text{shutdown}}$ , the charge current will be reduced to prevent  $V_{\text{IN}}$  to drop below  $V_{\text{shutdown}}$ .



4. 3 → 4: If  $V_{IN} < V_{shutdown}$  for longer than 1min ( $t_{shutdown}$ ), "engine off" is detected and charging is disabled. If  $V_{IN} > V_{shutdown}$  before  $t_{shutdown}$  runs out, charging remains enabled.
5. 4 → 5: If  $V_{start(delay)} < V_{IN} < V_{start}$ , charging is enabled after  $t_{start}$  delay (configurable).

### 4.3. Setup for Euro 6 vehicles

Finding the correct engine shutdown detection settings for Euro-6 vehicles can be challenging. The alternator management system may, while driving, decide to turn the alternator on or off based on the vehicle's electrical needs. When the alternator is switched off, the voltage from the starter battery may drop to the static battery voltage (~12.6 V), causing the engine shutdown detection system to incorrectly "assume" that the engine is off. During this phase, the Orion XS will not charge, potentially resulting in an undercharged auxiliary battery.

For Euro-6 vehicles, there are various charging strategies, even within the same brand and model. This variability makes it challenging to determine the best approach for your situation. For example, within the VW T6 community, some users successfully utilise engine shutdown detection, while others experience undercharged auxiliary batteries.

It's important to note that the alternator management system can be activated or deactivated based on the vehicle's electrical needs. When enough electrical loads are present, the alternator will produce at least a float-level voltage (~13.8V), which can be detected by the engine shutdown detection system. If your base load is sufficiently high, the alternator will remain active, allowing the engine shutdown detection to function correctly. If not, it may be more effective to disable engine shutdown detection in VictronConnect and use an external signal to activate charging via the remote on/off function.

Be aware that external signals may have drawbacks that should be understood. Some of these methods are described below.

- **Ignition switch:**

It is common to use the ignition switch to activate charging. While this method is not inherently wrong, it allows the Orion XS to discharge the starter battery even when the engine is not running. This requires the user to be vigilant about when charging is permitted to avoid a flat starter battery. Therefore, we do not recommend using the ignition switch to enable charging.

- **D+:**

The D+ signal, which comes from the alternator, indicates that the alternator is active. However, in Euro-6 vehicles, this signal is often no longer provided, making it unusable. There are D+ simulator devices that generate a signal based on alternator voltage, but these are typically low-tech alternatives to engine shutdown detection. Since you have already determined that engine shutdown detection is insufficient, this method is likely not suitable for your needs.

- **Vehicle Engine Running Signal:**

This is the most reliable method, as the vehicle's system provides the most accurate information. However, accessing this signal can be challenging, and it may require activating this function in the vehicle's software.

- **Vibration sensor:**

This device generates a voltage when it detects engine vibrations. However, be aware that external vibrations, such as those from transport on a boat or train, or even loud music, can be mistaken for a running engine. To mitigate this, it is advisable to power the vibration sensor from an ignition-switched source, ensuring that charging is only permitted when both the ignition is on and vibrations are detected.

- **CAN bus interface (with engine running):**

This device reads the engine running command broadcasted on the CAN bus and converts it into an on/off signal. However, this requires tapping into the CAN bus, and the ease of access can vary between different vehicles.

## 4.4. LED indicators

The Orion XS has 3 coloured LEDs showing the charger's status. Their meaning and behaviour are explained below.

### LED status:

LED behaviour	Description	Symbol
On	Permanently on	●
Off	Permanently off	○
Very slow blinking	Blinking 1x per 1.6s	○ •
Slow blinking	Blinking 2x per 1.6s	○ ○
Blinking	Blinking 4x per 1.6s	○ ○ ○
Fast blinking	Blinking 8x per 1.6s	○ ○ ○ ○ ○
Pulsating	Short pulses per 1.6s	○ —  ○

### LED indications overview:

Orion XS status	Bulk LED	Absorption LED	Float LED
Off	○ —  ○	○	○
Error mode	○	○ •	○ •
Identify	○ ○	○ ○	○ ○
Power supply mode	●	●	○
Bulk mode	●	○	○
Absorption mode	○	●	○
Float mode	○	○	●
Storage mode	○	○	○ —  ○
Equalisation mode	○	○	○ •
Repeated absorption mode	○	○ ○	○
BatterySafe	○ ○	○	○
Software update	○	○ ○	○ ○
Other	○ —  ○	○	○

## 4.5. Setup & monitoring with VictronConnect

This chapter will help you get the most out of your Orion XS using the [VictronConnect App](#) and requires minimal knowledge of this battery charger.

For more general information on the [VictronConnect App](#), how to install it, how to pair it with your device and how to update the firmware, see the [VictronConnect manual](#).

### 4.5.1. Setup

VictronConnect allows to change or adjust various settings of the Orion XS. This is possible through the settings option, which can be accessed by clicking on the cog wheel icon in the top right corner of the screen. The setting options vary depending on the selected operating mode.

### 4.5.2. Charger mode settings

When in Charger Mode, these are the available settings:	
<b>Function:</b> Allows for the choice between “Charger” or “Power supply” mode. When Charger mode is selected, the Orion XS will follow the charge algorithm. For more information about the charge algorithm, please read the <a href="#">Features [2]</a> section.	
<b>Charger enabled/disabled:</b> The charger is enabled by default. Use the switch to disable the charger if necessary.	
<b>Input current:</b> Limits the maximum current drawn from the input source. This is particularly important to avoid overloading an alternator or other weak input sources. The value can be adjusted between 1A and 50A in 0.1A increments.	
<b>Output current:</b> Limits the maximum output current. The value can be adjusted between 1A and 50A in 0.1A increments.	
<b>Battery settings:</b> Allows to change the battery settings in order to adjust the absorption voltage, float voltage, and others to fit the battery being charged; see the <a href="#">Charger mode - Battery settings [16]</a> section for details.	
<b>Engine shutdown detection:</b> Allows three voltage limits and a delay time to be selected. One voltage limit is used to determine whether the engine has stopped, and two are used to detect whether the engine is running (again). Normally, a minimum difference of 0.2V is used for optimal operation. If desired, the protection can still be disabled by the user. For more information, please read the <a href="#">Engine shutdown detection [12]</a> and <a href="#">Engine shutdown detection &amp; input voltage lock-out [18]</a> sections.	
<b>Input voltage lock-out:</b> Allows to choose between two thresholds, one to set the lock-out value and another for the restart value. Normally, a minimum difference of 0.5V is recommended for proper operation. The protection can still be disabled if desired by the user. For more information about the input voltage lock-out, please read the <a href="#">Engine shutdown detection [12]</a> section.	

### 4.5.3. Charger mode - Battery settings

- **Battery preset:**

- Battery preset allows to select the battery type, accept factory defaults, or enter your own preset values to be used for the battery charging algorithm. The Absorption voltage, Float voltage, Storage voltage, Bulk time limit, Re-bulk voltage offset, Adaptive absorption time and Absorption time settings are all configured to a preset value - but can also be user-defined.
- User-defined presets can be stored in the preset library - in this way, installers will not have to define all the values each time they are configuring a new installation.
- By selecting Edit Presets, custom parameters can be set depending on the selected preset (battery type). Be sure to follow the battery manufacturer's recommendations for your battery type. The main parameters are as follows:

- **Absorption voltage**

- **Float voltage**

- **Storage voltage**

- **Equalization voltage** (disabled for the Victron Lithium Smart Battery preset)

- **Temperature compensation** (disabled for the Victron Lithium Smart Battery preset)

- **Low temperature cut-off** (configurable for lithium batteries)

Note that this setting only takes effect when the battery temperature is shared by other devices, for example, by a BMV-712 or SmartShunt in a VE.Smart network. This setting is not effective if a BMS controls the charger.

- **Expert mode:**

Activating Expert mode enables additional settings, depending on the selected preset. Note that the defaults work well for most cases. Change expert settings only if your equipment and battery has special requirements:

- **BatterySafe** (prevent excessive gassing by automatically limiting the rate of voltage increase)

- **Bulk time limit**

Set the maximum bulk time allowed for the charger.

- **Re-bulk voltage offset** (when the battery voltage drops 0.1V below the re-bulk voltage for one minute, the charge cycle will restart)

The re-bulk offset voltage determines what is the offset between the float voltage (or absorption if it is lower) and the re-bulk voltage. The re-bulk voltage is the battery voltage threshold that triggers another charge cycle. For example, when the charger cannot maintain the battery voltage due to a high load, the battery voltage will fall, and a new charge cycle will be started once the battery voltage drops below the re-bulk voltage.

- **Absorption duration** (Adaptive, fixed absorption)

The absorption time depends on whether the adaptive absorption time algorithm is used or not. If **Adaptive absorption time** is not enabled, the charger uses a **Fixed absorption time** that is user-selectable. When the **Adaptive absorption time** is enabled, the charger will determine the absorption time based on the bulk elapsed time of that charge cycle. The **Maximum absorption time** is also set by the user in this case.

- **Maximum absorption time**

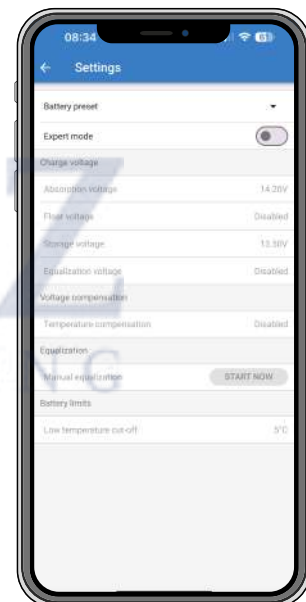

- **Tail current** (the charger will end absorption and switch to float or recondition when the charge current drops below the tail current threshold)

- **Repeated absorption**



<ul style="list-style-type: none"> <li>• <b>Equalization current percentage</b> (maximum current during equalization will be this percentage of the max charge current)</li> <li>• <b>Equalization stop mode</b> (Automatic on voltage, fixed time)</li> <li>• <b>Maximum equalization duration</b></li> <li>• <b>Manual equalization</b></li> </ul>	
--	--

#### 4.5.4. Power supply mode

<p><b>Orion XS [serial number]</b> or a specified custom name confirms the connected device.</p>	
<p><b>Mode icon:</b> indicates which mode the Orion XS is operating in (in this case <b>Power Supply Mode</b>).</p>	
<p><b>Output voltage:</b> Voltage measured at the output terminals of the device.</p>	
<p><b>Output current:</b> Output amperage.</p>	
<p><b>Output power:</b> Output power in Watts.</p>	
<p><b>Input voltage:</b> Voltage measured at the input terminals of the device.</p>	
<p><b>Input current:</b> Current drawn by the charger.</p>	
<p><b>Input power:</b> Input power in Watts.</p>	
<p><b>Why is the power supply off?:</b> Appears instead of the Power Supply Mode text and displays the reason why the Orion XS is turned off.</p>	

#### 4.5.5. Power supply mode settings

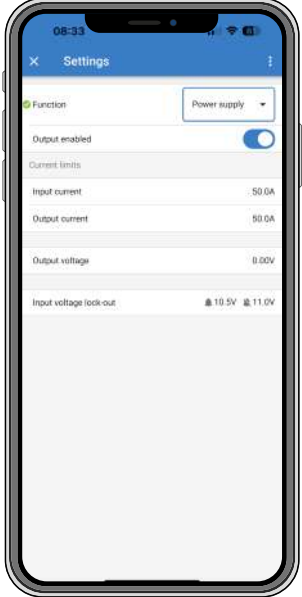
<p><b>Function:</b> Allows you to choose between Charger and Power Supply Mode. When the Power Supply Mode is selected, the Orion XS keeps the output voltage stable as specified in the setting.</p>	
<p><b>Output enabled/disabled:</b> Output is enabled by default. Use the switch to disable the output if necessary.</p>	
<p><b>Input current:</b> Limits the maximum current drawn from the input source.</p>	
<p><b>Output current:</b> Limits the maximum output current.</p>	
<p><b>Output voltage:</b> Allows to choose the output voltage when Power Supply Mode is selected. Note that the minimum and maximum voltages needs to be within the product limit (i.e.: 10V to 17V for a 12V output Orion XS).</p>	
<p><b>Input voltage lock-out:</b> Allows to choose between two thresholds. One to set the shutdown level and another for the restart value. Normally, a minimum difference of 0.5V is recommended for proper operation.</p>	
<p><b>Input voltage lock-out:</b> Allows to choose between two thresholds. One to set the shutdown level and another for the restart value. Normally, a minimum difference of 0.5V is recommended for proper operation.</p>	

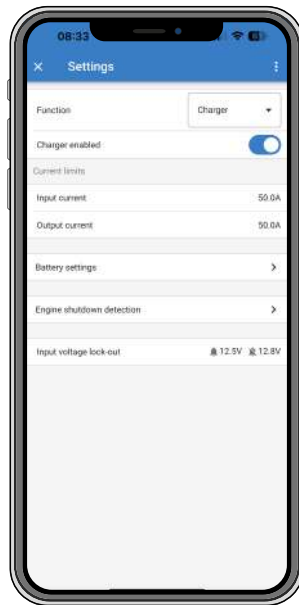

### 4.5.6. Engine shutdown detection & input voltage lock-out



#### Engine shutdown detection

To configure engine shutdown detection settings, open VictronConnect, connect to your Orion XS and from the status page press the cog icon to get to the Settings page.

The following settings can be changed with VictronConnect:

<p><b>Engine shutdown detection enabled/disabled:</b> The engine shutdown detection is always enabled by default whenever the charger mode is selected. When the function is disabled or when power supply mode is selected, the engine is considered to be running, so no shutdown detection will take place.</p>	<p>Engine shutdown detection enabled When disabled, the engine is always considered to be running.</p> 
<p><b>Alternator type:</b> For the type of alternator you can choose between "Smart alternator", "Regular alternator" and "User defined". When the "Smart alternator" option is selected, the default values for the smart alternator will be applied to the engine shutdown detection settings. The same will happen when "Regular alternator" option is selected. When any of the settings differs from the default values of the last two option, the "User defined" option will be selected. Default: smart alternator.</p>	
<p><b>Start voltage (<math>V_{start}</math>):</b> At this level, charging starts immediately. Default: 14V/28V.</p>	<p>Start voltage</p> <p>When the input voltage reaches this level, the engine is immediately considered to be running, allowing the charge procedure to start.</p> <p>— 14.00 +</p> <p>CANCEL OK</p>
<p><b>Delayed start voltage (<math>V_{start(delay)}</math>):</b> Smart alternators can generate a lower voltage when the engine is running, therefore a lower start level is necessary for these systems. To ensure that the starter battery is recharged after starting the engine, charging of the auxiliary/service battery is delayed during this condition. The energy used during starting must be replenished to ensure that the starter battery remains properly charged. Default: 13.3V/26.6V (smart alternator) and 13.8/27.4V (regular alternator).</p>	<p>Delayed start voltage</p> <p>When the input voltage is above this level for more than the "Delayed start voltage delay", the engine is considered to be running, allowing the charge procedure to start. This delay is useful to allow the starter battery to be recharged after starting up the engine, for example.</p> <p>— 13.30 +</p> <p>CANCEL OK</p>
<p><b>Delayed start voltage delay (<math>t_{start\ delay}</math>):</b> Recharge time for the starter battery during start voltage mode. Example: If the starter draws 150A for 5 seconds to start the engine, approx. ~0.2Ah is drawn from the starter battery. If, during engine idling, the alternator can only generate 20A, it takes <math>150A/20A \times 5s = 37.5s</math> to recharge the starter battery. Default: 120 seconds.</p>	<p>Delayed start voltage ...</p> <p>Delay to be used for the "Delayed start voltage".</p> <p>— 120s +</p> <p>CANCEL OK</p>

<p><b>Shutdown voltage (<math>V_{\text{shutdown}}</math>):</b> This level corresponds with the engine being off. This keeps the starter battery fully charged and provides a hysteresis with respect to the start level. The hysteresis must be large enough to prevent <math>V_{\text{IN}}</math> to drop to <math>V_{\text{shutdown}}</math> which would result in charge current reduction. Action will be taken after <math>t_{\text{shutdown}}</math> runs out (1 minute); this allows charging during temporary low-voltage conditions. Default: 13.1V/26.2V (smart alternator) and 13.5V/27V (regular alternator).</p> <p>Setting range for start and stop voltages: 9 to 35V</p>	
--	---

**Input voltage lock-out**

<p><b>Setup input voltage lock-out:</b> Input voltage lock-out is the minimum level at which charging is allowed, below this level charging stops immediately. Default (in charger mode): lock-out: 12.5V/25V; restart: 12.8V/25.6V. Default (in power supply mode): lock-out: 10.5V/21V; restart: 12V/24V.</p> <p><b>When 'forced charging' is enabled, current will be drawn from the starter battery if the engine is not running. Setting the lock-out level very low or deactivating the input voltage lock-out can result in a depleted starter battery.</b></p>	
<p>To setup input voltage lock-out, two criteria are important:</p> <ul style="list-style-type: none"> <li>• <b>Minimum alternator voltage:</b> A smart alternator can operate at very low alternator voltage (&lt;12.5V/25V) e.g. when the vehicle accelerates. Charging during this low voltage is allowed during <math>t_{\text{shutdown}}</math> as shown in "engine shutdown detection sequence 3→4". If charging must remain enabled during this period, the lock-out level must at least be set below the minimum alternator voltage.</li> </ul> <p>Note: When the input undervoltage period exceeds <math>t_{\text{shutdown}}</math>, engine shutdown detection will disable charging.</p> <ul style="list-style-type: none"> <li>• <b>Voltage drop across the input cable:</b> As seen in "engine shutdown detection sequence 1→3", <math>V_{\text{IN}}</math> will be lowered by <math>V_{\text{cable}}</math>. When the alternator voltage drops quickly (smart alternator), the voltage control needs some time to reduce charge current and keep <math>V_{\text{IN}}</math> at <math>V_{\text{shutdown}}</math>. During this adjustment period, <math>V_{\text{IN}}</math> can even drop below <math>V_{\text{lock-out}}</math>, which activates the undervoltage protection and stops charging. To prevent this, <math>V_{\text{lock-out}}</math> must be set as follows: <math>V_{\text{lock-out}} \leq V_{\text{shutdown}} - V_{\text{cable}}</math>.</li> </ul> <p><b>Example:</b> Calculate the input cable voltage drop:</p> <ul style="list-style-type: none"> <li>• Distance between starter battery and charger: 5m</li> <li>• <math>V_{\text{shutdown}} = 13,1\text{V}</math>. Recommended wire gauge: 16mm<sup>2</sup></li> <li>• Cable resistance: ~1,1 mΩ/m @20 °C, thus <math>R_{\text{cable}} = 1,1\text{m}\Omega \times 10\text{m} (2 \times 5\text{m}) = 11\text{m}\Omega</math></li> <li>• At a maximum input current of 50A, this results in:</li> <li>• <math>V_{\text{cable}} = 11\text{m}\Omega \times 50\text{A} = 550\text{mV}</math></li> <li>• <math>V_{\text{lock-out}} \leq V_{\text{shutdown}} - V_{\text{cable}} = 13,1\text{V} - 550\text{mV} = 12,55\text{V}</math>.</li> </ul> <p>Cable connections, external fuses, temperature, etc. influence the total cable resistance.</p>	



#### 4.5.7. Product information page

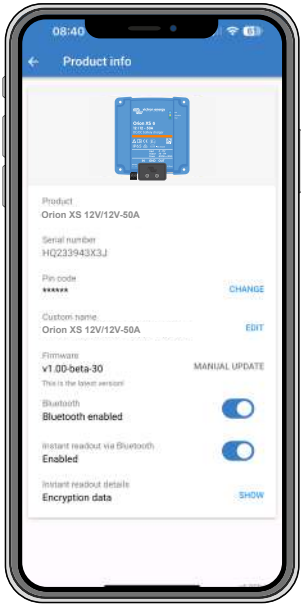

By clicking the  button on the top right of the Settings menu, it is possible to access the product information screen:

<p><b>Product</b> shows the Orion XS model.</p>	
<p><b>Serial number</b> shows the serial number of the unit.</p>	
<p><b>Pin code</b> allows the pin code to be changed. This is recommended to be done so settings and information won't be easy to access.</p>	
<p><b>Custom name</b> allows you to change a custom product name to your liking. By default, the product name "Orion XS" plus the serial number is displayed.</p>	
<p><b>Firmware</b> shows the firmware version currently installed on the device and also allows the charger to be updated if required.</p>	
<p><b>Bluetooth:</b> Bluetooth is enabled by default and can be disabled if necessary. To re-enable Bluetooth, please see the "How to disable and re-enable Bluetooth" chapter in the <a href="#">VictronConnect manual</a>.</p> <p><b>Note that re-enabling Bluetooth requires a <a href="#">VE.Direct to USB interface</a> connection between the Orion XS and a PC, Mac or Android device. iOS devices such as the iPhone and iPad do not support serial USB devices.</b></p>	
<p><b>Instant readout via Bluetooth:</b> Use the slider to disable/enable Instant readout.</p>	
<p><b>Instant readout details:</b> Displays the MAC address and encryption key for the unit.</p>	



### 4.5.8. Monitoring

### 4.5.9. Charger mode - Status screen

<p><b>Orion XS [serial number]</b> or a specified custom name confirms the connected device.</p>	
<p><b>Mode icon:</b> indicates which mode the Orion XS is operating in (in this case <b>Charger Mode</b>).</p>	
<p><b>Charger State:</b></p> <ul style="list-style-type: none"> <li>• <b>Bulk:</b> During this stage, the Orion XS supplies the set charging current to quickly charge the batteries. When the battery voltage reaches the Absorption voltage setting, the Orion XS activates the Absorption stage.</li> <li>• <b>Absorption:</b> From this stage, the Orion XS switches to the constant voltage mode, where a pre-set absorption voltage suitable to the battery type (see <a href="#">Charger mode - Battery settings [16]</a>) is applied. When the Absorption time has elapsed, the Orion XS activates the Float stage.</li> <li>• <b>Float:</b> During this stage, the float voltage is applied to the battery to maintain a fully charged state. When the battery voltage drops below Re-bulk voltage for at least 1 minute, a new charge cycle will be triggered.</li> <li>• <b>Storage:</b> During this phase, storage voltage is applied to the battery. If the battery has been connected to the battery charger for more than 48 hours, further lowering the charging voltage can prevent corrosion in lead-acid batteries.</li> <li>• Other possible states depending on the system and battery settings are: Off (engine not running or other reason), Repeated absorption, Equalize, Auto-equalize, BatterySafe, External control (controlled by a BMS), Power Supply Mode</li> </ul>	
<p><b>Output voltage:</b> Voltage measured at the output terminals of the device.</p>	
<p><b>Output current :</b> Output amperage.</p>	
<p><b>Output power:</b> Output power in Watts.</p>	
<p><b>Input Voltage:</b> Voltage measured at the input terminals of the device.</p>	
<p><b>Input current:</b> Current drawn by the charger.</p>	
<p><b>Input power:</b> Input power in Watts.</p>	

#### 4.5.10. Charger mode - Graph screen

<p>Orion XS [serial number] or a specified custom name confirms the connected device.</p>	
<p><b>Charger State Graph:</b> indicates the current charging state of the Orion XS and provides a short description of the current state.</p>	

#### 4.5.11. History screen

<p>The history page shows a summary of the charge cycles over the previous 40 cycles. Swipe the screen to the right or left to show any of the 40 cycles. Each column represents a cycle. Tapping on one of the bars reveals further information about duration and current for each of the charge states. Other items are:</p>	
<p><b>Status:</b></p>	
<p><b>Elapsed:</b></p>	
<p><b>Charge:</b> The accumulated charge current</p>	
<p><b>Maintain:</b> The current that keeps the battery fully charged during the float or storage phase.</p>	
<p><b>Type:</b> Battery profile used</p>	
<p><b>Vstart:</b> The lowest battery voltage at the start of the charge cycle</p>	
<p><b>Vend:</b> The lowest battery voltage at the end of the charge cycle</p>	
<p><b>Operation time:</b> Accumulated run time of the Orion XS</p>	
<p><b>Cycles started:</b> Number of charge cycles started</p>	
<p><b>Cycles completed:</b> The number of charge cycles completed (must have reached float or storage voltage stage)</p>	
<p><b>Charged Ah:</b>Total amphours charged with the Orion XS</p>	

#### 4.5.12. Trends screen

The VictronConnect app allows data to be displayed graphically via the trends screen. The prerequisite is that the VictronConnect app must be open and connected with the Orion XS. The data is not stored permanently. The following parameters can be displayed:

- Input voltage
- Input current
- Input power
- Output voltage
- Output current
- Output power
- Battery temperature (only if it is provided by an external device, for example, a BMW via a VE.Smart Network).



#### 4.5.13. Instant readout over BLE

VictronConnect can display key data of the Orion XS (and other compatible smart products) on the Device list page without the need to connect to the product. This includes visual notifications of warnings, alarms, and errors that enable diagnostics at a glance. Please see the [Instant Readout chapter](#) in the VictronConnect manual for more information and how to set it up.

The advantage is:

- Better range than a regular Bluetooth connection
- No need to connect to the smart product
- Key data at a glance
- Encrypted data



## 4.6. Monitoring with a GX device

Device List				08:39
A VM-3P75CT HQ23183CME			93.0 W	>
Lynx Smart BMS HQ2318PR5D3	79%	26.69V	-0.4A	>
MultiPlus-II 24/3000/70-32			Bulk	>
Orion XS 12/12-50A HQ233943X3J	12.00V	0.0A	0W	>
PSC IP43 24 25...HQ2230FQPF2			Off	>
SmartSolar Charger MPPT 75/15			0W	>
Pages				Menu

When the Orion XS is connected to the GX device via its VE.Direct port, it can also be monitored and turned on/off via a GX device's remote console or the VRM portal. The following requirements are necessary for this:



- A GX device such as [Cerbo GX](#) and [Ekran GX](#).
- A [VE.Direct cable](#) or a [VE.Direct to USB interface](#).
- Optionally, an internet connection of the GX device to the [VRM portal](#). This enables remote monitoring from anywhere worldwide and adds VictronConnect Remote (VC-R) functionality. Orion XSVC-R enables remote access even without a direct Bluetooth connection as if standing directly next to the device, with the same functionality. For more details on VC-R, see the [VictronConnect manual](#).

### Setup

Connect the Orion XS to the GX device using a VE.Direct cable. It will then automatically appear in the device list of the GX device.

### Monitoring

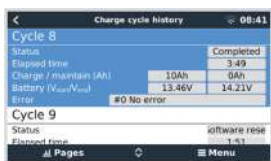
To get to the Orion XS detail page, tap the Orion in the Device List or select the Orion using the cursor keys and then press the right cursor key. The detail page offers the following options:

<p><b>Switch:</b> Turns the Orion XS on and off. Depending on the configuration made in VictronConnect, either charger or power supply mode will be started.</p>	
<p><b>Input:</b> Shows the input voltage, current and power as measured at the input terminals.</p>	
<p><b>Battery:</b> Shows the output voltage, current and power as measured at the output terminals.</p>	
<p><b>State:</b> Displays the current status of the charger or power supply mode. Possible states depending on the device mode and settings are: Off (engine not running, or other reason, check the Off reason in VictronConnect), Bulk, Absorption, Float, Storage, Repeated-absorption, Equalize, Auto-equalize, BatterySafe, Ext. control (controlled by a BMS), Power Supply.</p>	
<p><b>Network status:</b> This can be either Slave if controlled by DVCC or Standalone device if not controlled by DVCC.</p>	
<p><b>Error:</b> If the Orion XS is in an error state, the error code will be displayed here.</p>	
<p><b>Overall history:</b> Provides an overview of operation time, number of charge cycles, charged Ah, etc.</p>	
<p><b>Charge cycle history:</b> Provides an overview of the last 30 charging cycles.</p>	
<p><b>Device:</b> Provides additional device information and allows to assign a custom device name.</p>	

## 4.7. Remote sensing with VE.Smart Networking

With VE.Smart Networking, remote battery voltage, temperature and current sensing can be added to your Orion XS when paired with a battery sensor like a BMV, SmartShunt or Smart Battery Sense. The Orion XS will receive the available information from the battery and use that data to optimise its charge parameters.

The sensed battery current is used for the tail current setting, while the battery temperature is used for temperature voltage compensation and protection.

The sensed battery voltage is used to compensate for voltage drop over the battery cables. Compensating for voltage drop creates a mismatch between the voltage measured at the Orion XS connector and the battery terminals:

$$V_{\text{OrionXSconnector}} = V_{\text{battery}} + V_{\text{compensation}}$$

 Voltage drop compensation ( $V_{\text{compensation}}$ ) saturates at 2V.

### Effects when the battery is disconnected

By disconnecting the battery, the physical connection between the charger and the remote sensing device is lost. The charger is not aware that the battery is disconnected and will increase its output voltage to compensate for the voltage difference. In this case, the output voltage will rise until it reaches the saturation level (=2V). E.g. with  $V_{\text{battery}}=12.6\text{V}$ , the output voltage ( $V_{\text{connector}}$ ) saturates at 14.6V.

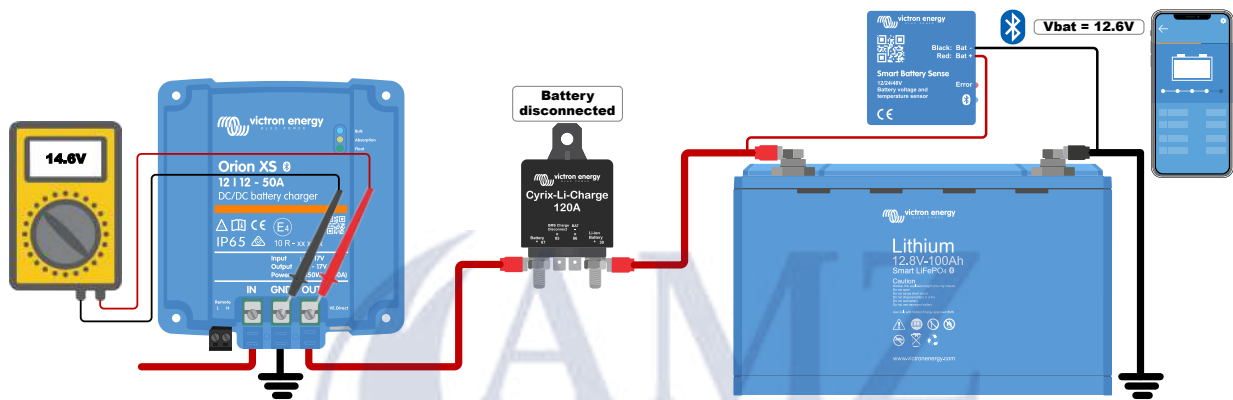

Although it is not a problem that the Orion XS outputs a higher voltage, it can be confusing when analysing the voltage levels in a system and comparing them with the readings of the VictronConnect/GX device. Therefore, when analysing, make sure that all necessary physical connections are made.

## 5. Troubleshooting & Support

Consult this chapter in case of unexpected behaviour or if you suspect a product fault.

The correct troubleshooting and support process is first to consult the common issues described in this chapter.

Should this fail to resolve the issue, contact the point of purchase for technical support. If the point of purchase is unknown, refer to the [Victron Energy Support webpage](#).

### 5.1. The Orion XS is not operational

Once powered up and operational, the controller LED(s) will illuminate or flash and can communicate with VictronConnect via Bluetooth or via the VE.Direct port.

Once the charger is powered up, VictronConnect can be used to:

1. Check the charger status
2. Check for error messages
3. Update firmware
4. Make or change settings

If the unit does not power up, use this chapter to check the possible reasons why the controller is not operational.

#### 5.1.1. Visual Check

Before any electrical inspection, it is a good idea to visually check the charger to determine if the charger is damaged.

1. Check for mechanical damage and burn marks.  
Note that this kind of damage is usually not covered by warranty.
2. Are the connecting wires making contact with the plug/terminals?
3. Are the wires stripped to the correct length and tightened with the correct torque?  
See [Recommended torque \[6\]](#).
4. Inspect the battery terminals.

If there are burn marks on the terminals or if the cables or connectors are molten, this damage is usually not covered by warranty.



### 5.1.2. Battery supply check

Check whether the charger is receiving battery power; this can be on the input and output or both.

Battery voltage can normally be checked via the VictronConnect App, a display or a GX device. However, in this case, the charger is not operational, so the battery voltage must be measured manually. Measure the battery voltage at the charger battery terminals with a multimeter.



The reason for measuring the battery voltage at the charger terminals is to rule out possible problems with the wiring, fuses and/or circuit breakers in the path between the battery and the charger.

Depending on the result of the measurement, do the following:

Battery voltage	Operational state	Action to take
No voltage	Off	Restore the battery supply
Correct voltage	Off	There might be a fault with the charger Contact your Victron dealer or distributor
Correct voltage	On	Check for active errors via the VictronConnect app, a monitor or a GX device.

### 5.1.3. Battery not charged

This chapter lists all possible reasons why the Orion XS does not charge the batteries, and the steps you can take to remedy the situation.

There are a number of reasons why the Orion XS might not charge the batteries.

For example:

- Issues with the battery or system wiring
- Incorrect settings
- The Orion XS is remotely controlled by a BMS or other device via its remote on/off

In the VictronConnect App, you will find a clickable link at the bottom of the status screen that says 'Why is the charger off?'

When you click the link, an explanation will appear as to why the charger is disabled. Check this first.

### 5.1.4. Reverse battery polarity

Reverse polarity is when the positive and the negative battery cables have been accidentally swapped. The battery negative has been connected to the positive terminal and the battery positive has been connected to the negative terminal.

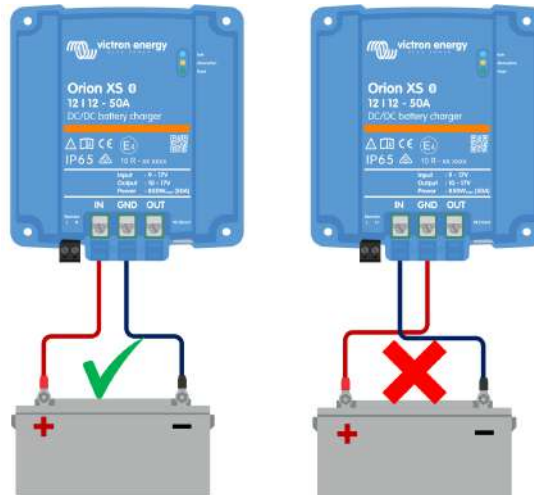

Example of correct and incorrect (reverse) battery polarity

Example of correct and incorrect (reverse) battery polarity



- Be aware that a red or positive labelled cable might not necessarily mean that the cable is indeed a positive cable. A wiring or labelling mistake could have been made during installation.
- Reverse battery polarity can be accompanied with a blown battery fuse (one that is located in the battery cable).



The Orion XS is not protected against reverse battery polarity; any damage caused by this is not covered under warranty.

### 5.1.5. Battery full

Once the battery is full, the Orion XS will stop charging or greatly reduce the charge current. This is especially the case when at the same time the DC loads in the system are not consuming any power from the battery.

To find out the battery's state of charge (SoC), check the battery monitor (if present), or alternatively, check what charge stage the controller is in. Also observe if the charge cycle is (briefly) progressing through these charge stages

- Bulk stage: 0-80% SoC
- Absorption stage: 80-100% SoC
- Float or storage stage: 100% SoC.

Be aware that it may also be possible for the Orion XS to think the battery is full when it is not. This can occur when the charge voltages have been set too low, causing the Orion XS to switch to the absorption or float stage prematurely.

### 5.1.6. Remote terminal is missing, is disconnected or external control is active

Generally speaking, both the remote connector and the wire loop need to be present for the controller to be operational. In some advanced systems, the remote on/off connector can be connected to an external device, a switch, a relay, or another type of external control, like a battery BMS system.

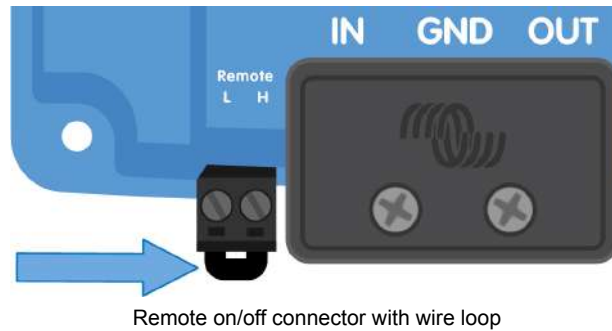

There are several ways to activate via remote on/off.

Use modes of the remote on/off:

- ON when the L and H terminals are interconnected via a switch or a relay contact
- ON when the L terminal is pulled to battery minus (ON switch level < 6V)
- ON when the H terminal is high (ON switch level > 4V)

#### General remote on/off terminal check

1. Check if the connector with the wire loop is present.
2. Check if the connector has been inserted all the way in.
3. Check that the wire loop is making electrical contact.



Be aware that if an external device is connected to the remote terminal, the wire loop has been removed, and one or two wires will be connected between the remote connector and the external device.

#### 5.1.7. The charger is disabled

Check the VictronConnect app to make sure the charger has been enabled.



VictronConnect enable/disable charger setting

## 5.2. Batteries are undercharged

This section deals with possible reasons why the Orion XS is not sufficiently charging the batteries and the steps you can take to check or remedy the situation.

Some signs of undercharged batteries:

- The battery takes too long to charge (> 10hrs).
- The batteries are not fully charged at the end of the charge cycle.
- The charge current from the Orion XS is less than expected.

#### 5.2.1. Too much DC load

The Orion XS not only charges the batteries but also provides power for the system's loads.

The battery will only be charged when the power available exceeds the power being drawn by the loads in the system, like lights, fridge, inverter, and so on.

If the system battery monitor is correctly installed and configured, you can see how much current is going in (or out) of the battery, and the Orion XS will tell you how much current it is generating.

A positive sign alongside the current reading means that current is flowing into the battery, while a negative sign indicates that current is being drawn from the battery.

#### 5.2.2. Battery charge voltages are too low

If the battery voltages have been set too low, the batteries will not receive a full charge.

Check if the battery charge voltages (absorption and float) are set correctly. Consult the battery manufacturer's information for the correct charge voltages.

### 5.2.3. Battery is almost full

The Orion XS will reduce its charge current when the battery is almost full.

If the battery's state of charge is unknown, and the current is reducing while the engine is running, it can mistakenly be interpreted as the Orion XS being faulty.

The first current reduction takes place at the end of the absorption stage when the battery is approximately 80% charged.

During the absorption phase, when the battery is between 80% and 100% charged, the current is further reduced.

The float stage starts when the batteries are 100% full. During the float stage the charge current is very low.

To find out what the state of charge (SoC) of the battery is, check the battery monitor (if present), or alternatively, check the charge stage the Orion XS is in.

- Bulk: 0-80% SoC
- Absorption: 80-100% SoC
- Float or storage: 100% SoC

### 5.2.4. Battery cable voltage drop

If there is a voltage drop over the battery cables, the Orion XS will output the correct voltage, but the batteries will receive a lower voltage. Battery charging will take longer, potentially leading to undercharged batteries.

In case there is a large voltage drop, the battery cables and cable connection will need to be checked, and if there are issues, they will need to be rectified.

The voltage drop can have the following causes:

- Battery cables with insufficient cross-sectional area
- Badly crimped cable lugs or terminals
- Loose terminal connections
- Bad or loose fuse(s)

#### Battery cable voltage drop check

This check can only be performed if the Orion XS is in the bulk charge stage and is charging with full current.

1. Measure the voltage on the battery terminals of the Orion XS using the VictronConnect app or a multimeter.

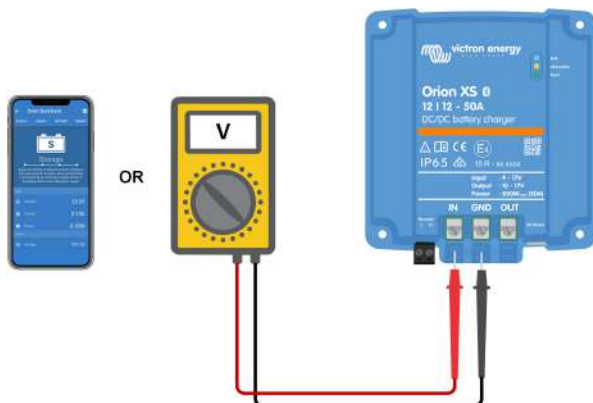

2. Measure the battery voltage on the terminals of the battery using a multimeter.

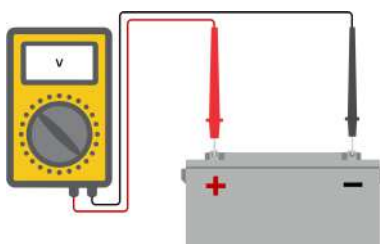

- Compare the two voltages to see if there is a voltage difference.

### 5.2.5. Temperature difference between Orion XS and battery

It is important that the ambient temperatures of the battery and the controller are equal. The Orion XS will measure the ambient temperature at the start of the charge cycle and assume it is the same as the battery temperature. It will then adjust the charge voltage based on this temperature measurement and its compensation setting.

Once the Orion XS goes into float stage, it will measure the ambient temperature again and will use that measurement to adjust the voltages again.

If there is a large ambient temperature difference between Orion XS and battery, the battery will be charged at the wrong voltages.

### 5.2.6. Insufficient alternator power

Check if the Orion XS reaches the float charge stage. To investigate, look at the history tab in the VictronConnect app. The histogram displays how long the batteries have been charged in the Bulk, Absorption and Float stages for the last 40 cycles. If you click on one of the histogram columns, you will see a breakdown of the charge stages.

Use the charge times to see if the alternator power rating is properly sized for your requirements. A system which never reaches the float stage could have the following issues:

- Not enough power during idling: The power output of an alternator can be reduced to ~50% during idling.
- Too much load
- Overheated alternator causing it to reduce power output

### 5.2.7. Wrong temperature compensation setting

If the temperature compensation coefficient is set incorrectly, it can result in undercharging or overcharging of the batteries. You can adjust the temperature compensation setting through VictronConnect.

To determine the correct temperature compensation coefficient for your battery, consult the battery documentation. When in doubt, you can use the default value of  $-16.20\text{mV}/^\circ\text{C}$  for lead-acid batteries and disable the temperature compensation setting for lithium batteries.

### 5.2.8. Battery charge current too low

Check the Input/Output current limit settings in the VictronConnect app.

If the Input/Output current limit has been set too low, it will take longer to charge the batteries.

## 5.3. Batteries are overcharged



Batteries that are being overcharged are very dangerous! There is a risk of battery explosion, fire or acid leakage. Do not smoke, create sparks or have open flames in the same room as where the batteries are located.



Overcharging batteries will cause battery damage and can be caused by:

- Incorrect charge voltage settings
- Battery voltage setting too high
- High current and undersized batteries
- Battery faults
- Too high current, while the battery is not accepting charge anymore because of ageing or prior mistreatment

### 5.3.1. Battery charge voltages too high

If the battery charge voltages are set too high, this will cause the batteries to overcharge.

Check if all the battery charge voltages (absorption and float) are set correctly.

The charge voltages have to match the recommended voltages as stated in the battery manufacturer's documentation.

### **5.3.2. Battery unable to deal with equalization**

During equalization, the battery charge voltage will be quite high, and if the battery is unsuitable to be equalized, the battery will be overcharged.

Not all batteries can be charged with equalization voltages. Check with the battery manufacturer if your battery needs a periodic equalizing charge.

Generally speaking, sealed batteries and lithium batteries cannot be equalized.



### 5.3.3. Battery old or faulty

A battery that is at the end of its service life or has been damaged by incorrect use can be prone to being overcharged.

A battery contains a number of cells that are connected in series. When a battery is old or has been damaged, a likely scenario is that one of these cells is not operational anymore.

When the faulty battery is charged, the damaged cell will not accept charge, and the remaining cells will receive the broken cell's charge voltage and thus will be overcharged.

To fix this, replace the battery. In case of multiple battery systems, replace the whole battery bank. Mixing batteries of different ages in one battery bank is not recommended.

It is hard to tell what exactly happens to a battery during its lifetime. The Orion XS will keep 40 cycles of battery voltage history. If the system also contains a battery monitor, or if the system is connected to VRM, the battery voltages and the cycle history of the battery can be accessed. This will give a complete picture of the battery history, and it can be determined if the battery is near the end of its service life or has been abused.

#### To check if the battery is close to its cycle life:

1. Find out how many charge and discharge cycles the battery has been subjected to. Battery lifetime correlates to the number of cycles.
2. Check how deep the battery has been discharged on average. A battery will last for fewer cycles if deeply discharged, compared to more cycles if discharged less deep.
3. Refer to the battery datasheet to find out how many cycles at what average discharge the battery is capable of. Compare this with the battery history and determine if the battery is near the end of its service life.

#### To check if the battery has been misused:

1. Check if the battery has been totally discharged at all. Total and very deep discharge will damage a battery. Check the battery monitor setting history on the VRM portal. Look for the deepest discharge, the lowest battery voltage, and the number of full discharges.
2. Check if the battery has been charged with too high voltage. Very high charge voltage will damage the battery. Check the maximum battery voltage and the high voltage alarms in the battery monitor. Check if the measured maximum voltage has exceeded the battery manufacturer's recommendations.

### 5.4. Full rated output not reached

There are a few reasons why the Orion XS is not reaching its full-rated output.

- **Alternator rating (during idling) too small**

If the alternator power rating is less than the Orion XS nominal power rating, the Orion XS cannot output more power than the connected alternator can provide.

- **Temperature protection active**

When the Orion XS heats up, eventually the output current will derate. When the current is reduced, naturally the output power will reduce as well.

The controller is operational up to an ambient temperature of 60°C, with a full rated output up to 40°C when mounted on a vertical surface with the terminals facing downwards and sufficient free space for ventilation.



With force air flow the product can even run at full power up to 60°C of ambient temperature.

If the Orion XS is located in a closed enclosure, such as a cabinet, make sure that cold air can enter and hot air can leave the enclosure. Mount vents in the enclosure.

For very hot environments consider mechanical air extraction or provide air conditioning.



## 5.5. Communication issues

This section describes issues that might arise when the Orion XS Orion XS is connected to the VictronConnect app, other Victron devices or third-party devices.

### 5.5.1. VictronConnect issues



For a full troubleshooting guide on the VictronConnect app, see the [VictronConnect manual](#).

### 5.5.2. VE.Direct port communication issues

These occurrences are not common, and if they occur, it is probably due to one of the issues listed in this paragraph.

- **Physical cable connector or data port issues**

Try using a different VE.Direct cable to check if the unit will now communicate. Ensure that the connector is inserted properly and deep enough. Is the connector damaged? Inspect the VE.Direct port; are there any bent pins? If this is the case, use long-nose pliers to straighten the pins **while the unit is not powered**.

- **VE.Direct communication issues**

To check if VE.Direct communication is operating correctly, connect the Orion XS to a GX device and check if the controller shows up on the GX device's list. If it does not show up, check that the TX port function in VictronConnect is set to Normal communication.

### 5.5.3. Bluetooth issues

Please note that it is highly unlikely that the Bluetooth interface is faulty. The problem is most likely caused by something else.

Use this section to quickly rule out some of the common causes of Bluetooth issues. For a full troubleshooting guide see the [VictronConnect manual](#).

- **Check if Bluetooth is enabled**

It is possible to enable/disable Bluetooth in the product settings. To re-enable:

Connect to the Orion XS via the VE.Direct port. Navigate to the controller settings and then to Product info. Re-enable Bluetooth.

- **Check if the controller is powered up**

Bluetooth is active as soon as the Orion XS is powered up.

This can be checked by looking at the LEDs:

If all LEDs are off, the unit is not powered up.

If any of the LEDs are on, blinking or pulsing at a few seconds interval, the unit is powered up and Bluetooth should be functional.

- **Check that Bluetooth is in range**

In open space, the maximum Bluetooth distance is about 20 meters. In a build-up area, inside a house, a shed, a vehicle or a boat this distance can be a lot less.

- **The Windows VictronConnect app does not support Bluetooth**

The Windows version of the VictronConnect app does not support Bluetooth. Use an Android, iOS or macOS device instead. Or alternatively, connect using a VE.Direct to USB interface.

- **The controller is missing in the VictronConnect device list**

Some steps to try to resolve this issue are:

Press the orange refresh button at the bottom of the VictronConnect device list and check if the Orion XS is now listed.

Only one phone or tablet can be connected to the Orion XS at any given time. Make sure no other devices are connected and try again.

Try to connect to another Victron product, does this work? If that also does not work, there probably is an issue with the phone or tablet.

Rule out any issues with the phone or the VictronConnect app by using another phone or tablet and try again.

If still unresolved, refer to the VictronConnect manual.

- **PIN code lost**

If you have lost the PIN code, you will need to reset the PIN code to its default PIN code. This is done in the VictronConnect app:

Navigate to the Device list of the VictronConnect app.

Enter the Orion XS's unique PUK code as printed on its product information sticker.

Click on the option symbol next to Orion XS listing.

A new window will open, which allows you to reset the PIN code back to its default: 000000.

- **How to communicate without Bluetooth**

In case Bluetooth is not functional, turned off or unavailable, VictronConnect can communicate via the unit's VE.Direct port. Or, if the unit is connected to a GX device, VictronConnect can communicate via VRM.

## 5.6. Settings or firmware issues

### 5.6.1. Incorrect settings

Incorrect settings can cause strange behaviour. Check that all settings are correct.

- If in doubt, it could be an option to reset all settings to default using the VictronConnect app and then make all required settings.
- Consider saving the existing settings before performing a reset.
- In most cases, the default setting can usually be used with only minor changes.
- If help is required with making settings, please refer to the manual or contact your Victron supplier or distributor.

### 5.6.2. Firmware issues

To rule out a firmware bug, update the firmware.



Always write down the firmware number before and after the update. This can be useful information should you need to request support.

On first connection, the controller might have updated the firmware. If the controller did not automatically ask for a firmware update, check if the controller is running the most up-to-date firmware and perform a manual update:

1. Connect to the controller
2. Click on the settings symbol
3. Click the option symbol
4. Go to product info
5. Check if you are running the latest firmware and look for the text: "This is the latest version"
6. If the controller does not have the most up-to-date firmware, perform a firmware update by pressing the update button

### 5.6.3. Interrupted firmware update

This is recoverable and is nothing to worry about. Just try to update the firmware again.

## 5.7. Error and warning code overview

The error and warning codes are displayed on the VictronConnect app or via a connected GX device.

### Error 1 - Battery temperature too high

- This error will auto-reset after the battery temperature has dropped. The charger will stop charging to prevent damaging the battery. If no external battery temperature sense is connected, it is assumed that during charger start-up or float, the Orion XS and battery temperature are equal. Therefore, a too hot charger in this state is interpreted as a too hot battery.

### Error 2 - Battery voltage too high

- This error will auto-reset after the battery voltage has dropped. This error can be due to other charging equipment connected to the battery or a fault in the charge controller.

### Error 17 - Controller overheated despite reduced output current

- This error will auto-reset after the charger has cooled down. Check the ambient temperature and check if the Orion XS is properly mounted for cooling.

### Error 21 - Current sensor issue

- The current measurement is out of range. Disconnect all wires, and then reconnect all wires, to make the charger restart. This error will not auto-reset. If the error remains, please contact your dealer, there might be a hardware defect.

### Error 26 - Terminal overheated

- Power terminals overheated, check wiring, including the wiring type and type of strands, and/or fasten bolts if possible. This error will auto-reset.

### Error 27 - Charger short circuit

- This condition indicates an over-current condition on the battery side. This error will auto-reset. If the error does not auto-reset, disconnect the charge controller from all power-sources, wait 3 minutes, and power up again. If the error persists, the charge controller is probably faulty.

### Error 28 - Power stage issue

- This error will not auto-reset. Disconnect all wires, and then reconnect all wires. If the error persists the charger is probably faulty.

### Error 33 – Input voltage to high

- This error will auto-reset after input voltage has dropped to a safe limit.

### Error 67 - BMS Connection lost

- This error shows when the charger is configured to be controlled by a BMS but does not receive any BMS control messages.
- In that situation; the charger stops charging by reducing its output voltage to the battery base voltage (12 V). This is a safety mechanism, and the reason for still enabling the output is to allow a system to self-recover from a low battery voltage situation.
- This error is only shown when the device is ready to initiate charging, not during "off" state. In case there is a permanent problem, the error will appear when willing to charge and clear when in "off" state, and so forth.
- 15s after the connection is lost the charger will lower the output voltage to base level, but the error is first shown after 3min, this allows the BMS to reconnect and prevents overkill of error notifications.
- Also, changing to base voltage is shown in VictronConnect as going from bulk directly to float, after the communication is re-established, the charger will go back to bulk again.

### Error 116 - Calibration data lost

- If the unit does not work and error 116 pops up as the active error, the unit is faulty. Contact your dealer for a replacement.
- If the error is only present in the history data and the unit operates normally, this error can be ignored safely. Explanation: when the units power up for the very first time in the factory, it does not have calibration data and an error 116 is logged. Obviously, this should have been cleared, but in the beginning, units left the factory with this message still in the history data.

### Error 117 - Incompatible firmware

- This error indicates that a firmware update did not complete, so the device is only partially updated. Possible causes are: device out of range when updating over the air, a cable got disconnected or power was lost during the update session. To fix this the update needs to be retried.
- When your GX device is connected to VRM, you can do a [remote firmware update](#). You can do this via the VRM website or using the VRM tab in VictronConnect. VictronConnect can also be used together with the firmware file to update using a Bluetooth connection.

#### **Error 119 - Settings data lost**

- The charger cannot read its configuration, and stopped. This error will not auto-reset. To get it working again:
  1. First, restore it to factory defaults. (top right in Victron Connect, click on the three dots).
  2. Disconnect the charge controller from all power-sources.
  3. Wait 3 minutes, and power up again.
  4. Reconfigure the charger.
- Please do report this to your Victron dealer and ask him to escalate it to Victron; as this error should never happen. Preferably include firmware version and any other specifics (VRM URL, VictronConnect screenshots or similar).

#### **Error 120 - Internal supply voltage error**

- The unit performs internal diagnostics when activating its internal voltage supplies. This error indicates that something is wrong with an internal supply voltage.
- This error will not auto-reset. Check the installation and restart the unit using the power-switch. If the error persists, the unit is probably faulty.

#### **Error 122 - History data corrupted**

- This error will not auto-reset.
- Clear the history data in VictronConnect to reset the error.

#### **Warning 150 - Battery temperature too high**

- Output voltage is reduced to nominal voltage (12V) to prevent battery damage.
- This warning will auto-reset after the battery temperature has dropped. If no external battery temperature sense is connected, it is assumed that during charger start-up or float, the Orion XS and battery temperature are equal. Therefore, a charger that is too hot in this state is interpreted as a too hot battery.

#### **Warning 151 - Battery temperature too low**

- The charging has been stopped because the battery temperature is too low.
- This is part of the battery protection mechanism and it is not necessarily indicating a problem. Lithium batteries can be damaged by charging them at low temperatures. If you think that this protection shouldn't have been triggered, contact your installer to adjust the related setting.

#### **Warning 160 - Current derate due to controller high temperature**

- The current is derated to control the internal temperature.
- This warning will auto-reset after the charger has cooled down. Check the ambient temperature and check if the Orion XS is properly mounted for cooling.

#### **Warning 161 - Short circuit detected**

- Over-current condition detected on the battery side.
- This warning will auto-reset. If the warning does not auto-reset, disconnect the charge controller from all power-sources, wait 3 minutes, and power up again. If the warning persists, the charge controller is probably faulty.

#### **Warning 162 - Power stage issue**

- Current rating limited to half of nominal current.
- Disconnect all wires, and then reconnect all wires. If the warning persists, the charge controller is probably faulty. This warning will not auto-reset.

## 6. Technical data

### 6.1. Technical specifications

Orion XS 12/12-50A DC-DC battery charger	
Input voltage range	9-17V
Output voltage adjust range	10-17V
Output voltage tolerance	+/- 0.25% (max)
Output voltage noise	10mV rms
Input and output current setting range	1 - 50A
Maximum constant short-circuit current	50A
Continuous output power up to 40 °C <sup>1)</sup>	700W
Maximum efficiency	98.5%
No-load current consumption	< 100mA
Standby current consumption	< 1.5mA
<b>Communication ports</b>	
Bluetooth Smart	Yes
VE.Direct	Yes
<b>Other</b>	
Operating temperature range	-20 to +60 °C (derating 1.5% per °C above 40 °C)
Protection category	IP65
DC connection	Screw terminals
Maximum cable cross-section	4AWG (21.2mm <sup>2</sup> )
Weight	0.330kg (0.73 lb)
Dimensions h x w x d	137.3 x 123.1 x 40mm (5.4 x 4.85 x 1.6 inch)
<b>Standards</b>	
Safety	IEC 62477-1
Emission	IEC 61000-6-3, EN 55014-1
Immunity	IEC 61000-6-2, IEC 61000-6-1, EN 55014-2
Automotive Directive	ECE R10-5
<p><sup>1)</sup> This applies to optimal cooling where the product is mounted as indicated in the manual with sufficient free space. In case of limited cooling, e.g. due to insufficient airflow, the charging current will be regulated back sooner. With an improved airflow (e.g. forced airflow), derating will take place far above <math>t_{amb}</math> 40°C.</p>	

### 6.2. Compliance

**SIMPLIFIED EU DECLARATION OF CONFORMITY:** Hereby, Victron Energy B.V. declares that the Orion XS 12/12-50A DC-DC battery charger is in compliance with Directive 2014/53/EU. The full text of the EU declaration of conformity is available at the following internet address: <https://ve3.nl/7r>.

**UK PSTI STATEMENT OF COMPLIANCE:** We, Victron Energy B.V., confirm that our product Orion XS 12/12-50A DC-DC battery charger complies with the security requirements outlined in Schedule 1 of The Product Security and Telecommunications Infrastructure (Security Requirements for Relevant Connectable Products) Regulations 2023. The official Statement of Compliance can be downloaded from <https://ve3.nl/7r>.

### 6.3. Enclosure dimensions

